









【LED照明 WA Light ・ LED面光源 Dotty Light 仕様】

| 種別 <SP照明> | 型式 | 写真 | 駆動電圧 (DC V) | 消費電力 (W) | 光源電力 (W) | 照度(lux) | | | 寸法(mm) | | | 備考 |
|--------------|------------|---|----------------|-------------|-------------|---------|-------|-------|--------|------|-----|---------------------------------------|
| | | | | | | 1m | 2m | 3m | (タテ) | (ヨコ) | (t) | |
| 3P | SL-MD3PEX |  | 6 | 2 | 1.6 | 200 | 52 | 26 | 37 | 103 | 27 | 防水タイプ 単3型電池×4本 約3.5H ACアダプター可 |
| 24P | SL-24PEX |  | 12 | 15 | 12.6 | 1,440 | 410 | 178 | 50 | 360 | 95 | スポット照明に 12ahバッテリーで7.5H ACアダプター可 |
| 48P | SL-MD48P |  | 12 | 54 | 47 | 4,900 | 1,280 | 544 | 210 | 300 | 40 | スポット照明に 防水タイプ 専用電源BOX付き |
| 60P | SL-MD60P |  | 12 | 72 | 57.3 | 8,250 | 2,270 | 1,010 | 210 | 360 | 50 | スポット照明に 防水タイプ 専用電源BOX付き |
| 5P | SL-MDC605P |  | 24 | 36.4 | 34.5 | 749 | 187 | 83 | 100 | 360 | 53 | エリア照明に 防水タイプ ACアダプター可 |

| 種別 <面光源> | 型式 | 写真 | 駆動電圧 (DC V) | 消費電力 (W) | 光源電力 (W) | 平均照度(lux) | 寸法(mm) | | | 備考 |
|-------------|-----------|---|----------------|-------------|-------------|-----------|--------|------|-----|------------|
| | | | | | | | (タテ) | (ヨコ) | (t) | |
| 108*108 | M-120A |  | 12 | 9.6 | 0.8 | 20,000 | 130 | 147 | 13 | 発光面108*108 |
| A2 | DOL-A2 |  | 24(12) | 48 | 45 | 8,000 | 496 | 670 | 15 | 発光面420*594 |
| A4 | DOL-A4 |  | 12 | 24 | 23 | 15,000 | 272 | 359 | 11 | 発光面210*297 |
| 両面発光 | DOL-60560 |  | 24 | 15 | 10.6 | 3,900×両面 | 100 | 600 | 21 | 発光面60*560 |

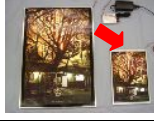

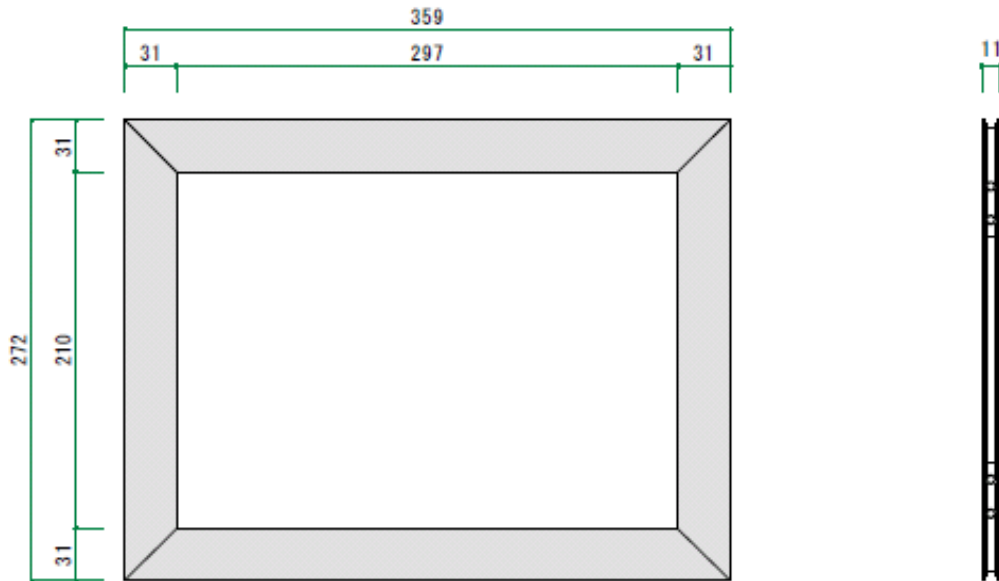
(fig.1)

Specification

< LED UNIT >

| | |
|--------------------------|------------|
| Model | DOL-A4 |
| Power (MAX) | 23W |
| LED | 0.2W 60Pcs |
| Luminous Flux | 936 lm |
| Illuminance | 36 lx (3m) |
| Size(mm) | (fig.1) |
| Weight | 1.5kg |
| International Protection | IP00 |

< CONTROL UNIT >

| | |
|-------------------|--------------|
| Model | SY-285D-CTL |
| Input Voltage | DC12V |
| Output Current | 2A |
| Size(mm) | 112W*60D*22H |
| Power Consumption | 24W |

Connection

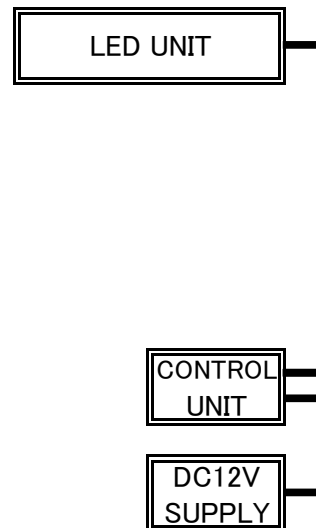

Lux & Area

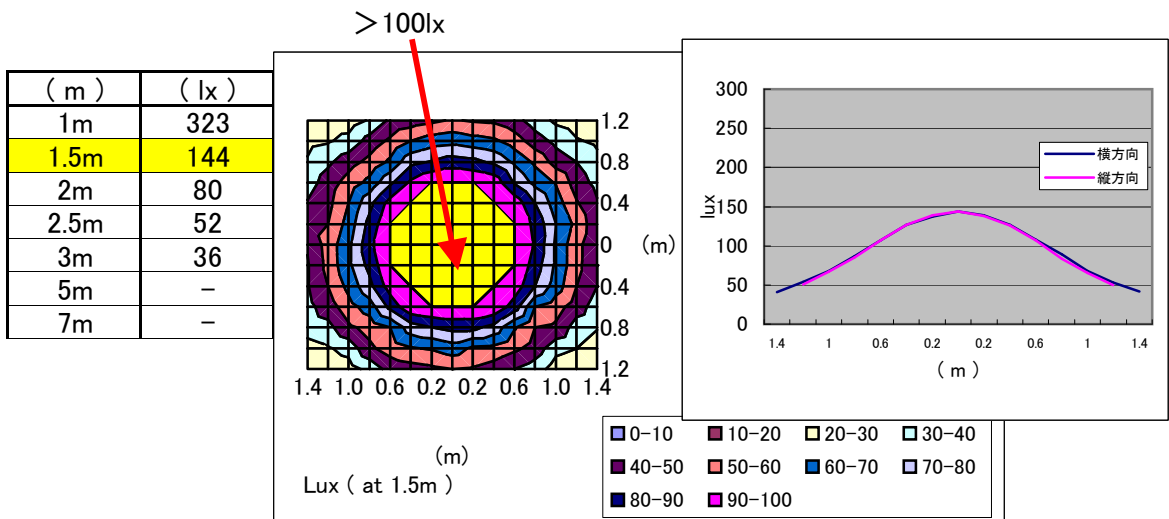

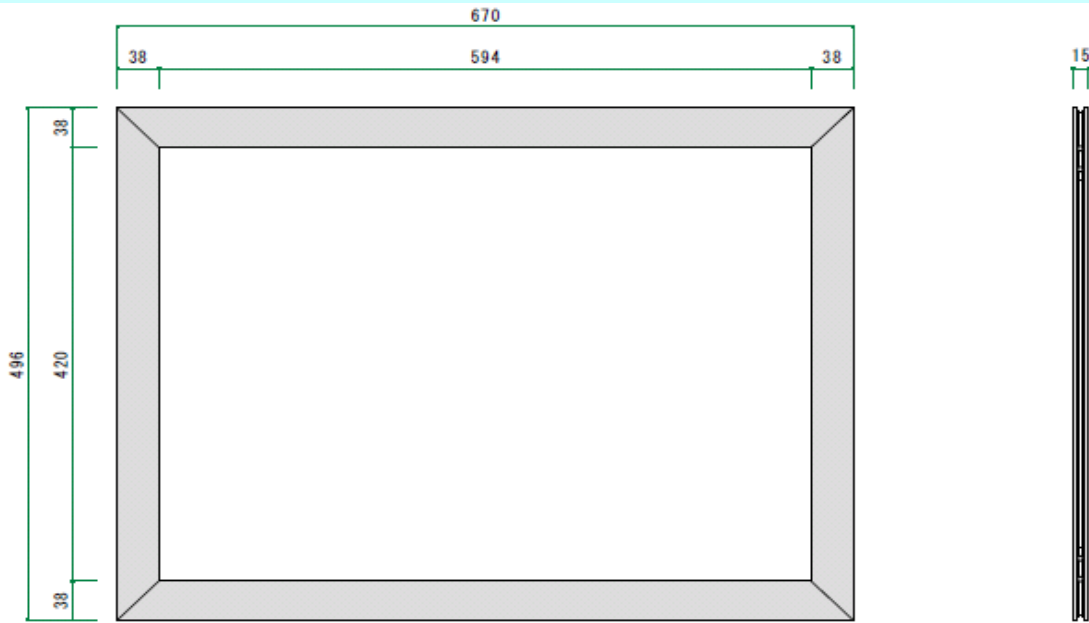

(fig.1)

Specification

< LED UNIT >

| | |
|--------------------------|-------------|
| Model | DOL-A2 |
| Power (MAX) | 45W |
| LED | 0.2W 120Pcs |
| Luminous Flux | 1996 lm |
| Illuminance | 70 lx (3m) |
| Size(mm) | (fig.1) |
| Weight | 5.9kg |
| International Protection | IP00 |

Connection

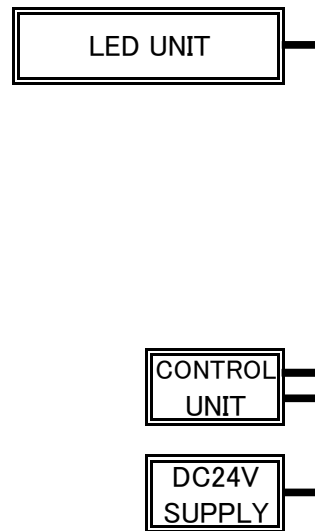

< CONTROL UNIT >

| | |
|-------------------|--------------|
| Model | SY-285D-CTL2 |
| Input Voltage | DC24V |
| Output Current | 2A |
| Size(mm) | 112W*60D*44H |
| Power Consumption | 48W |

Lux & Area

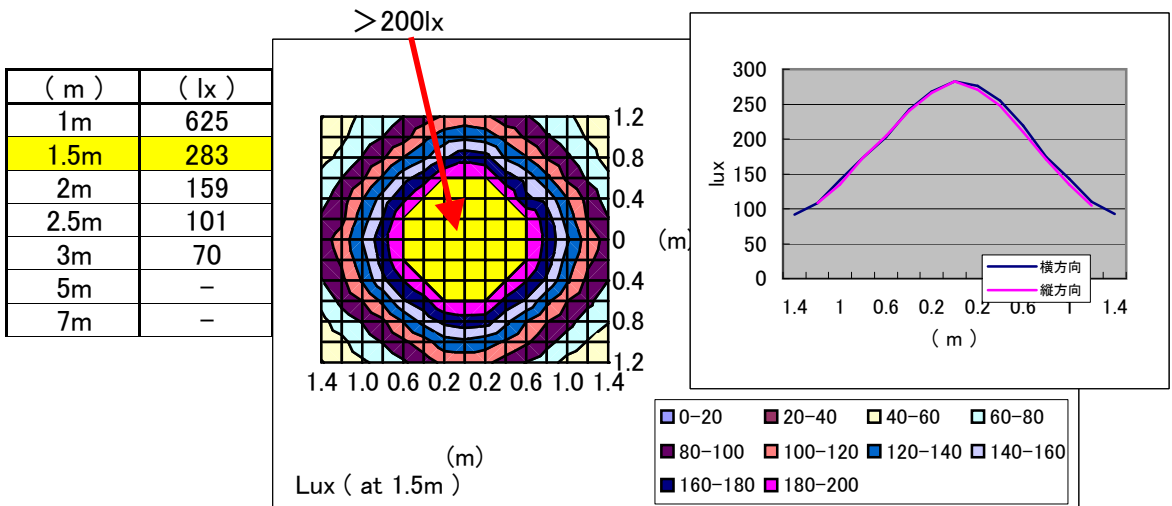

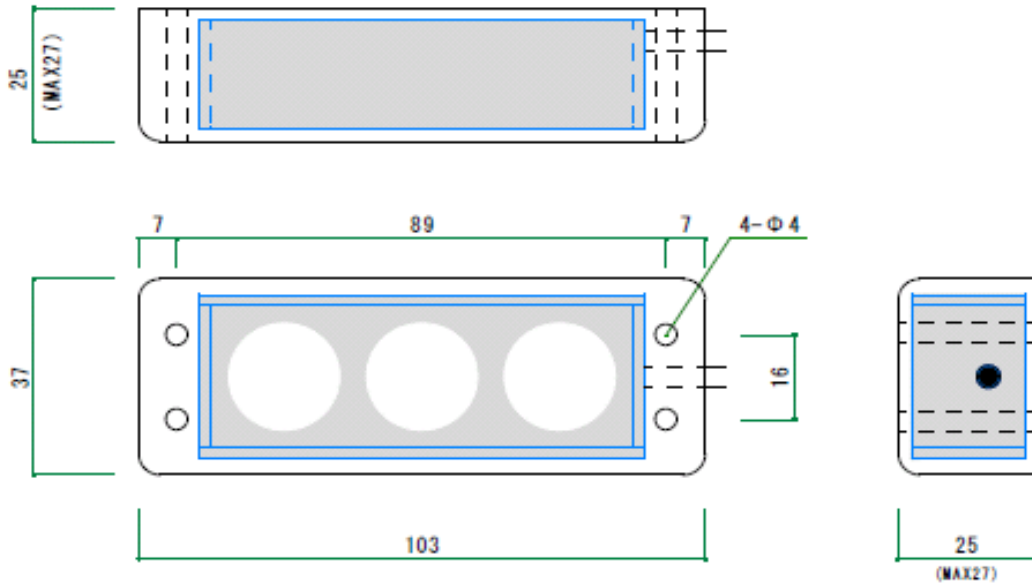

(fig.1)

Specification

< LED UNIT >

| | |
|--------------------------|------------|
| Model | SL-MD3PEX |
| Power (MAX) | 1.6W |
| LED | 0.5W 3Pcs |
| Luminous Flux | 127 lm |
| Illuminance | 22 lx (3m) |
| Size(mm) | (fig.1) |
| Weight | 125g |
| International Protection | IP67 |

Connection

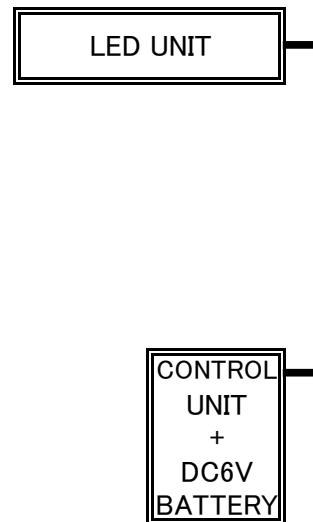

< CONTROL UNIT >

| | |
|-------------------|--------------|
| Model | SL-MD3PEX-BT |
| Input Voltage | DC6V |
| Output Current | 330mA |
| Size(mm) | 100W*60D*25H |
| Power Consumption | 2W |

Lux & Area

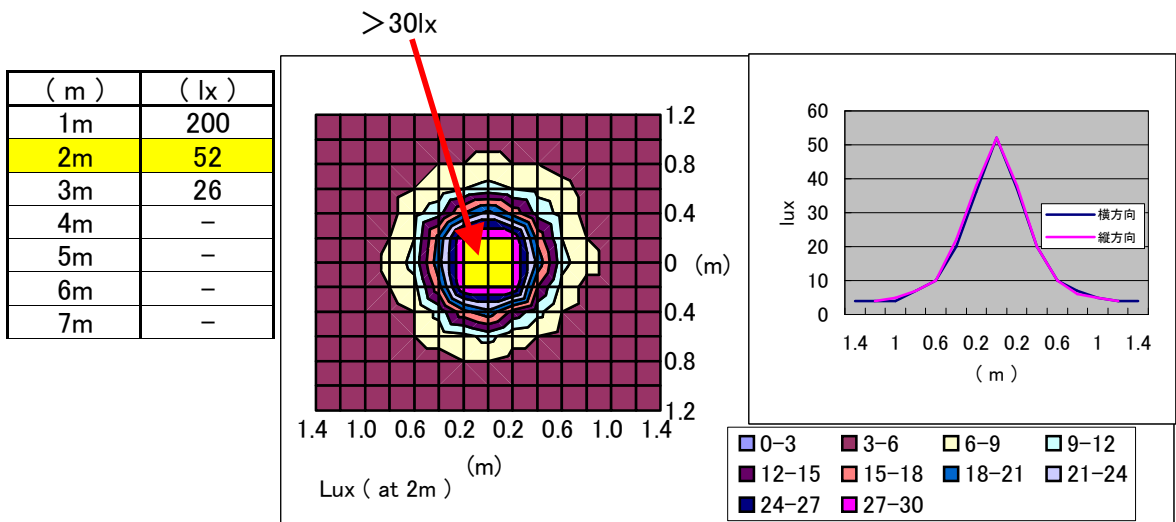

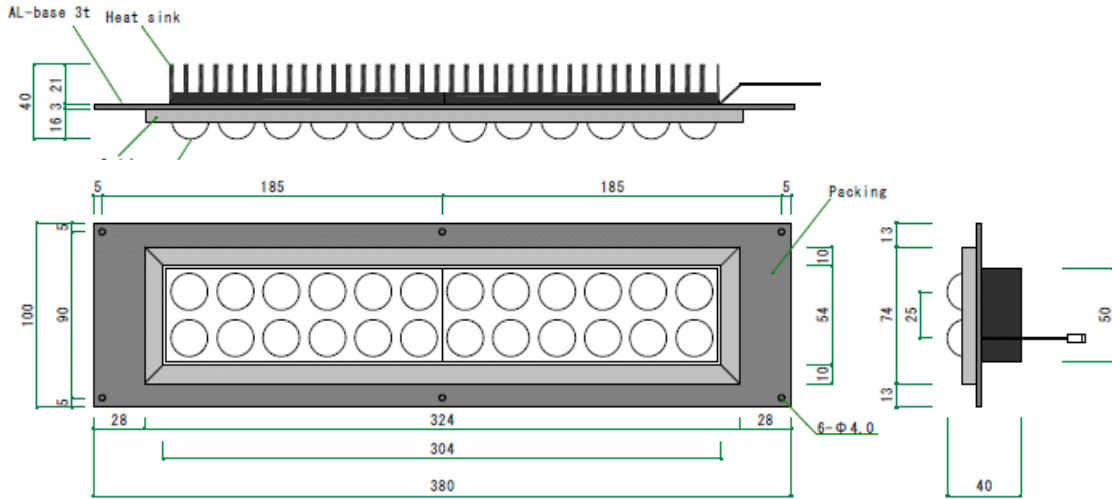

(fig.1)

Specification

< LED UNIT >

| | |
|--------------------------|-------------|
| Model | SL-MD24P |
| Power (MAX) | 12.6W |
| LED | 0.5W 24Pcs |
| Luminous Flux | 10,490 lm |
| Illuminance | 15 lx (10m) |
| Size(mm) | (fig.1) |
| Weight | 1.2kg |
| International Protection | IP67 |

< CONTROL UNIT >

| | |
|-------------------|--------------|
| Model | SY-285D-CTL |
| Input Voltage | DC12V |
| Output Current | 1.25A |
| Size(mm) | 112W*60D*22H |
| Power Consumption | 15W |

Connection

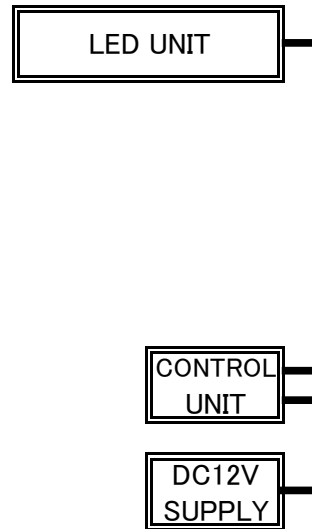

Lux & Area

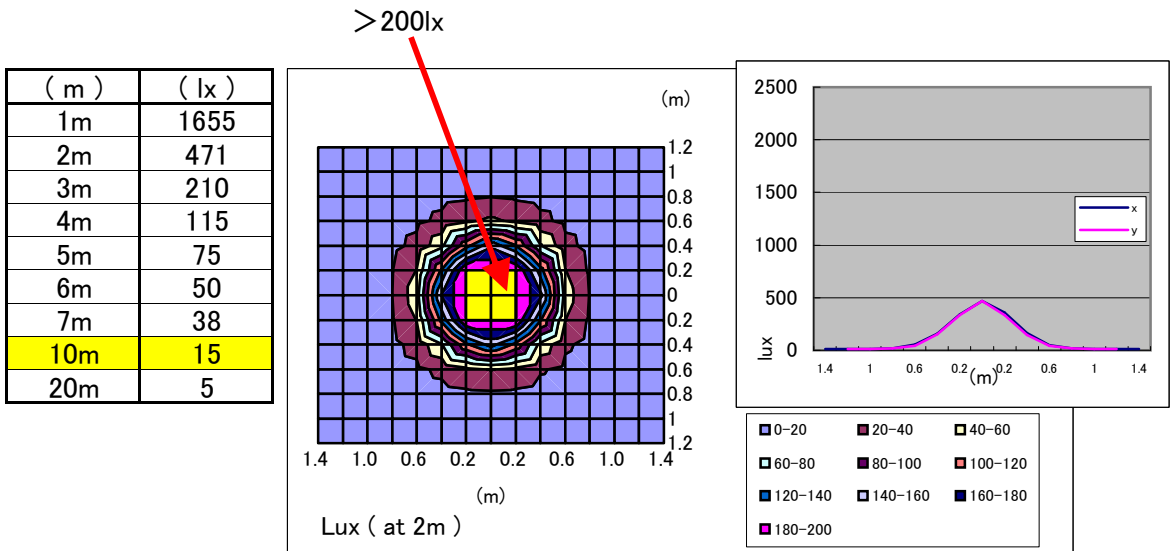

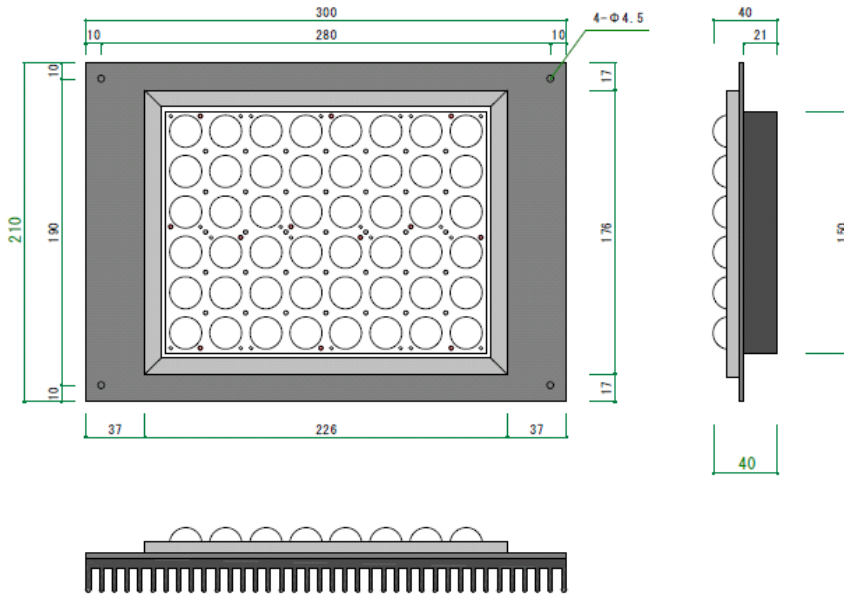

(fig.1)

Specification

< LED UNIT >

| | |
|--------------------------|-------------|
| Model | SL-MD48P |
| Power (MAX) | 47W |
| LED | 1.0W 48Pcs |
| Luminous Flux | 79,580 lm |
| Illuminance | 60 lx (10m) |
| Size(mm) | (fig.1) |
| Weight | 2.5kg |
| International Protection | IP67 |

< CONTROL UNIT >

| | |
|-------------------|--------------------|
| Model | SL-MD48P POWER BOX |
| Input Voltage | AC100~240V |
| Output Current | 4.2A |
| Size(mm) | 230W*140D*160H |
| Power Consumption | 58W (※1) |

※1) DC12VIN=54W

Connection

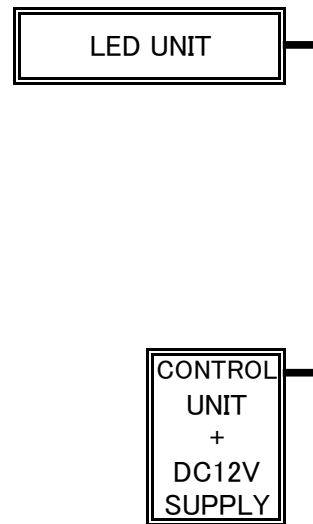

Lux & Area

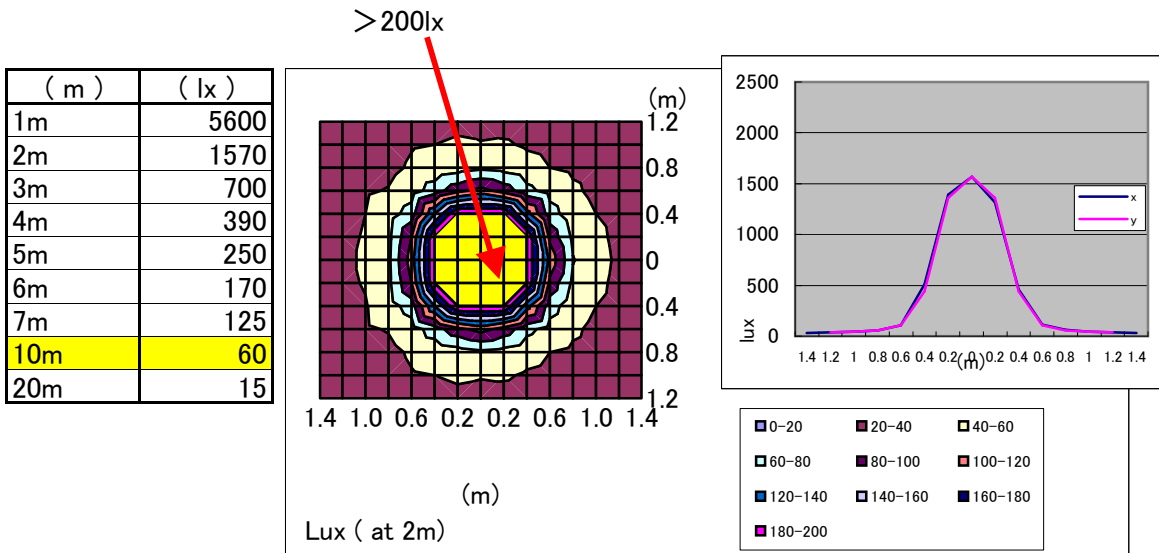

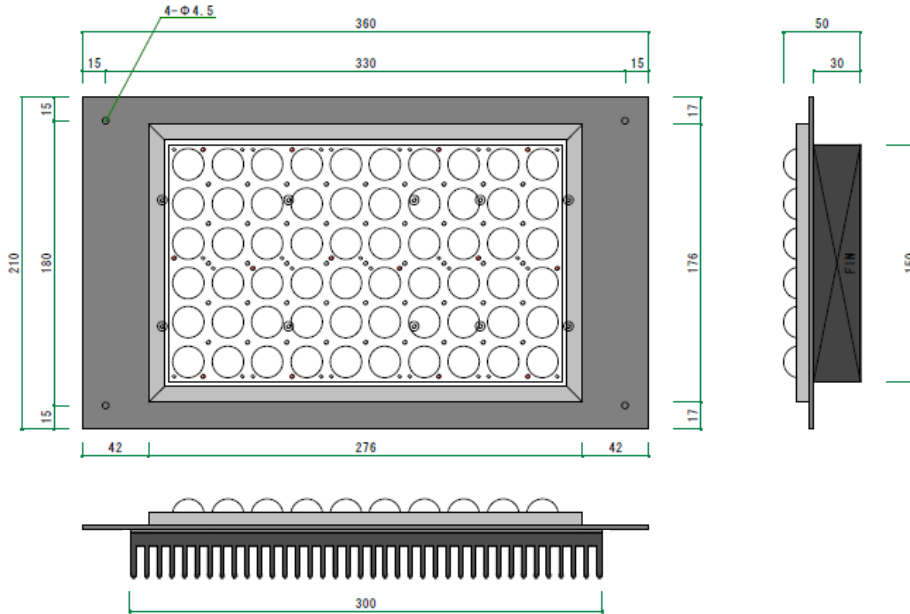

(fig.1)

Specification

< LED UNIT >

| | |
|--------------------------|-------------|
| Model | SL-MD60P |
| Power (MAX) | 58W |
| LED | 1.0W 60Pcs |
| Luminous Flux | 124,344 lm |
| Illuminance | 80 lx (10m) |
| Size(mm) | (fig.1) |
| Weight | 2.7kg |
| International Protection | IP67 |

Connection

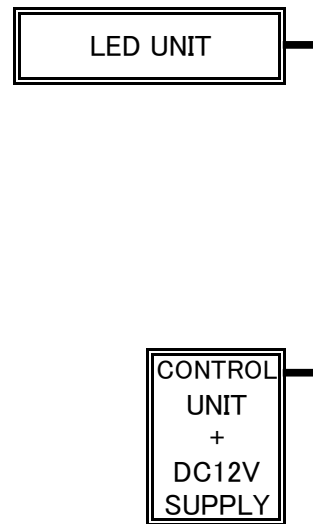

< CONTROL UNIT >

| | |
|-------------------|--------------------|
| Model | SL-MD60P POWER BOX |
| Input Voltage | AC100~240V |
| Output Current | 6.0A |
| Size(mm) | 230W*140D*160H |
| Power Consumption | 88W (※1) |

※1) DC12VIN=72W

Lux & Area

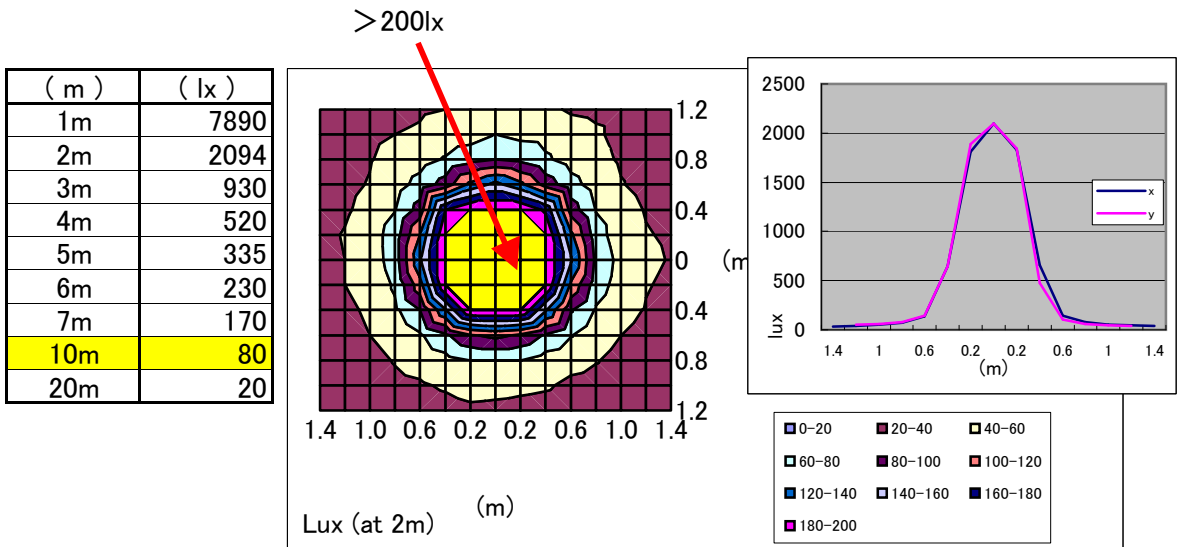

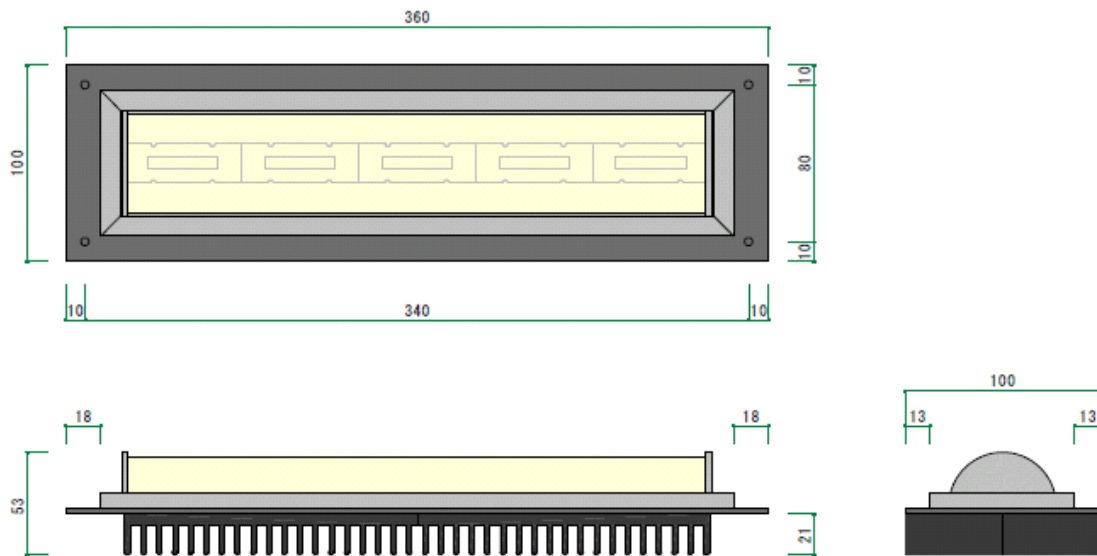

(fig.1)

Specification

< LED UNIT >

| | |
|--------------------------|------------|
| Model | SL-MDC605P |
| Power (MAX) | 35W |
| LED | 1.4W 30Pcs |
| Luminous Flux | 1,026 lm |
| Illuminance | 80 lx (3m) |
| Size(mm) | (fig.1) |
| Weight | 1.6kg |
| International Protection | IP65 |

< CONTROL UNIT >

| | |
|-------------------|--------------|
| Model | SY-285D-CTL |
| Input Voltage | DC24V |
| Output Current | 1.5A |
| Size(mm) | 112W*60D*22H |
| Power Consumption | 37W |

Connection

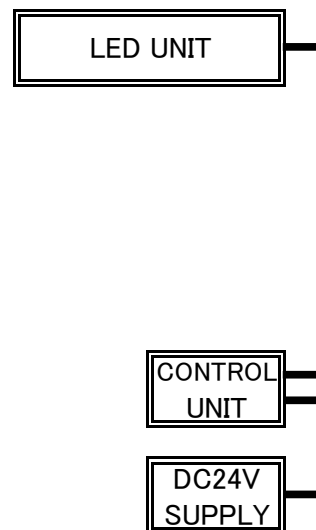

Lux & Area

For wide area lighting

